

MOMENT Rectangular Perch Tables

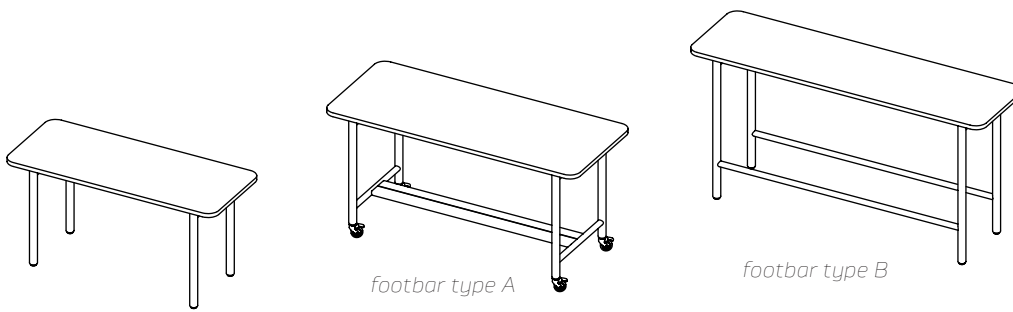

Options / Notes:

Casters: +\$115 (height not altered)

Custom Power Cutouts: +\$185

Table Height: 29.5" / 36" / 42"+\$250

***Footbar Type B:** 42" tall table ONLY

TFL Edge: edgeband ONLY

HPL Edge: edgeband / MDF 90 /

MDF Knife / MDF trim

PLY Edge: PLY 90 / PLY knife

Bag hooks standard on all tables

Dimensions			Surface Material			Footbars		Cable Cover
D	W	MODEL NUMBER	TFL	HPL/ Mirlux	PLY	TYPE A	TYPE B*	PLY
24"	48"	MTPCR2448	1960	2365	2580	+520	+300	+175
24"	60"	MTPCR2460	2080	2555	2885	+635	+500	+190
24"	72"	MTPCR2472	2205	2870	3195	+750	+535	+215
24"	84"	MTPCR2484	2320	3060	3435	+855	+570	+230
24"	96"	MTPCR2496	2380	3190	3620	+965	NA	+250
30"	48"	MTPCR3048	2050	2505	2905	+520	+300	+175
30"	60"	MTPCR3060	2175	2845	3180	+635	+500	+190
30"	72"	MTPCR3072	2310	3060	3460	+750	+535	+215
30"	84"	MTPCR3084	2445	3270	3745	+855	+570	+230
30"	96"	MTPCR3096	2505	3430	3955	+965	NA	+250

MOMENT Racetrack Perch Tables

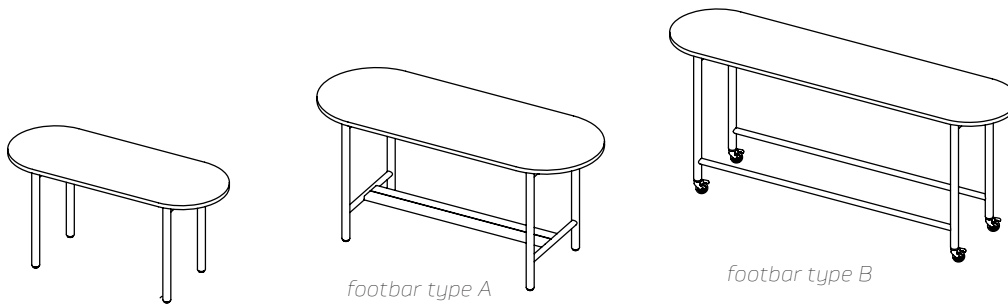

Options / Notes:

Casters: +\$115 (height not altered)

Custom Power Cutouts: +\$185

Table Height: 29.5" / 36" / 42"+\$250

***Footbar Type B:** 42" tall table ONLY

TFL Edge: edgeband ONLY

HPL Edge: edgeband / MDF 90 /

MDF Knife / MDF trim

PLY Edge: PLY 90 / PLY knife

Bag hooks standard on all tables

Dimensions			Surface Material			Footbars		Cable Cover
D	W	MODEL NUMBER	TFL	HPL/ Mirlux	PLY	TYPE A	TYPE B*	PLY
24"	60"	MTPC02460	2080	2555	2955	+635	+500	+175
24"	72"	MTPC02472	2205	2870	3195	+700	+535	+190
24"	84"	MTPC02484	2320	3060	3435	+855	+570	+215
24"	96"	MTPC02496	2380	3190	3620	+965	NA	+230
30"	60"	MTPC03060	2175	2845	3180	+635	+500	+175
30"	72"	MTPC03072	2310	3060	3460	+750	+535	+190
30"	84"	MTPC03084	2445	3270	3745	+855	+570	+215
30"	96"	MTPC03096	2505	3430	3955	+965	NA	+230

MOMENT Media Tables

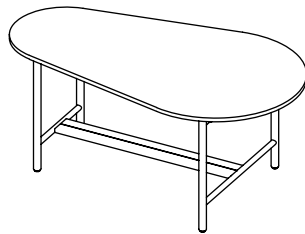
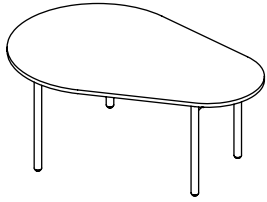

footbar type A

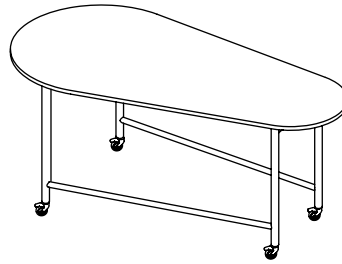

footbar type B

Options / Notes:

Casters: +\$115 (height not altered)

Custom Power Cutouts: +\$185

Table Height: 29.5" / 36" / 42"+\$250

***Footbar Type B:** 42" tall table ONLY

TFL Edge: edgeband ONLY

HPL Edge: edgeband / MDF 90 /

MDF Knife / MDF trim

PLY Edge: PLY 90 / PLY knife

Bag hooks standard on all tables

Dimensions			Surface Material			Footbars		Cable Cover
D	W	MODEL NUMBER	TFL	HPL/ Mirlux	PLY	TYPE A	TYPE B*	PLY
48"	72"	MTMD4872	3110	4120	4730	+810	+500	+215
48"	84"	MTMD4884	3345	4465	5055	+925	+535	+230
48"	96"	MTMD4896	3440	4690	5490	+1035	+570	+250

MOMENT Community Tables

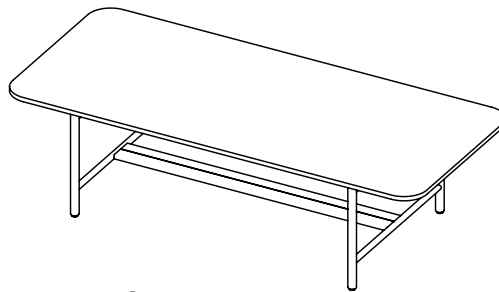
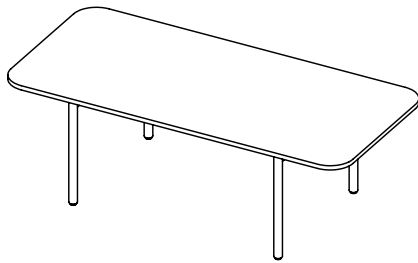

footbar type A

Options / Notes:

Casters: +\$115 (height not altered)

Custom Power Cutouts: +\$185

Table Height: 29.5" ONLY

Tops over 96" wide will be two pieces

TFL Edge: edgeband ONLY

HPL Edge: edgeband / MDF 90 /MDF

Knife / MDF trim

PLY Edge: PLY 90 / PLY knife

Bag hooks standard on all tables

Dimensions			Surface Material			Footbars		Cable Cover
D	W	MODEL NUMBER	TFL	HPL/ Mirlux	PLY	TYPE A	TYPE B	PLY
36"	84"	MTC3684	2560	3495	4155	+520	NA	+190
36"	96"	MTC3696	2770	3670	4405	+635	NA	+215
36"	108"	MTC36108	3045	4170	4865	+750	NA	+230
36"	120"	MTC36120	3130	4340	5115	+855	NA	+250
42"	84"	MTC4284	3220	4255	4880	+520	NA	+190
42"	96"	MTC4296	3320	4455	5170	+635	NA	+215
42"	108"	MTC42108	3620	4855	5650	+750	NA	+230
42"	120"	MTC42120	3720	5055	5940	+855	NA	+250
48"	84"	MTC4884	3345	4465	5180	+565	NA	+305
48"	96"	MTC4896	3440	4690	5490	+695	NA	+345
48"	108"	MTC48108	3755	5115	6025	+810	NA	+380
48"	120"	MTC48120	3860	5340	6340	+1020	NA	+415
<i>*Surface material options may be limited above 48" table depth</i>								
54"	84"	MTC5484	3460	4680	5480	+565	NA	+365
54"	96"	MTC5496	3565	4930	5830	+695	NA	+425
54"	108"	MTC54108	3895	5375	6390	+810	NA	+475
54"	120"	MTC54120	4005	5625	6740	+1020	NA	+535
60"	84"	MTC6084	3565	4895	5765	+745	NA	+425
60"	96"	MTC6096	3710	4855	6165	+875	NA	+500
60"	108"	MTC60108	4030	5640	6750	+990	NA	+570
60"	120"	MTC60120	4155	5920	7150	+1095	NA	+650

MOMENT Rectangular Session Tables

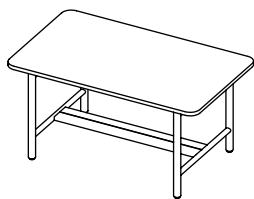

footbar type A

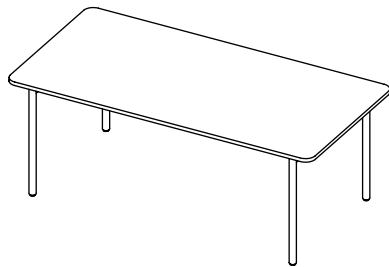

footbar type B

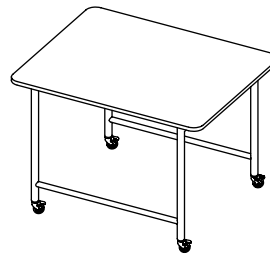

Options / Notes:

Casters: +\$115 (height not altered)

Custom Power Cutouts: +\$185

Table Height: 29.5" / 36" / 42"+\$250

***Footbar Type B:** 42" tall table ONLY

TFL Edge: edgeband ONLY

HPL Edge: edgeband / MDF 90 /

MDF Knife / MDF trim

PLY Edge: PLY 90 / PLY knife

Bag hooks standard on all tables

Dimensions			Surface Material			Footbars		Cable Cover
D	W	MODEL NUMBER	TFL	HPL/ Mirlux	PLY	TYPE A	TYPE B*	PLY
36"	48"	MTMR3648	2120	2770	3095	+520	+300	+175
36"	60"	MTMR3660	2270	3020	3405	+635	+500	+190
36"	72"	MTMR3672	2410	3245	3720	+750	+535	+215
36"	84"	MTMR3684	2560	3495	4155	+855	+570	+230
36"	96"	MTMR3696	2770	3670	4405	+965	NA	+250
42"	60"	MTMR4260	2800	3485	3930	+635	+500	+190
42"	72"	MTMR4272	3005	3805	4465	+750	+535	+215
42"	84"	MTMR4284	3220	4255	4880	+855	+570	+230
42"	96"	MTMR4296	3320	4580	5170	+965	NA	+250
48"	60"	MTMR4860	2880	3645	4280	+695	+500	+305
48"	72"	MTMR4872	3235	3995	4730	+810	+535	+345
48"	84"	MTMR4884	3345	4465	5180	+925	+570	+380
48"	96"	MTMR4896	3440	4690	5490	+1035	NA	+415
<i>*Surface material options may be limited above 48" table depth</i>								
54"	72"	MTMR5472	3220	4305	4990	+810	+535	+425
54"	84"	MTMR5484	3460	4680	5480	+925	+570	+475
54"	96"	MTMR5496	3565	4930	5830	+1035	NA	+535
60"	72"	MTMR6072	3320	4495	5250	+990	+535	+500
60"	84"	MTMR6084	3565	4895	5765	+1095	+570	+570
60"	96"	MTMR6096	3710	5170	6165	+1210	NA	+650

MOMENT Racetrack Session Tables

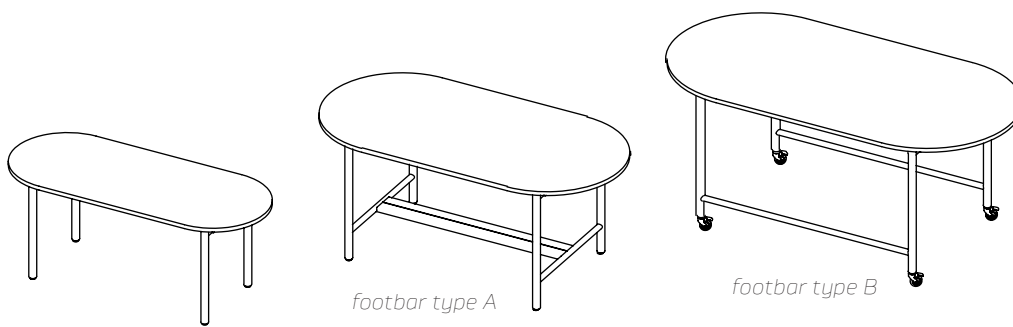

Options / Notes:

Casters: +\$115 (height not altered)

Custom Power Cutouts: +\$185

Table Height: 29.5" / 36" / 42"+\$250

***Footbar Type B:** 42" tall table ONLY

TFL Edge: edgeband ONLY

HPL Edge: edgeband / MDF 90 /

MDF Knife / MDF trim

PLY Edge: PLY 90 / PLY knife

Bag hooks standard on all tables

Dimensions			Surface Material			Footbars		Cable Cover
D	W	MODEL NUMBER	TFL	HPL/ Mirlux	PLY	TYPE A	TYPE B*	PLY
36"	60"	MTM03660	2270	3020	3405	+635	+500	+175
36"	72"	MTM03672	2410	3245	3720	+750	+535	+190
36"	84"	MTM03684	2560	3495	4155	+855	+570	+215
36"	96"	MTM03696	2770	3670	4405	+965	NA	+230
42"	72"	MTM04272	3005	3805	4465	+750	+535	+190
42"	84"	MTM04284	3220	4130	4880	+855	+570	+215
42"	96"	MTM04296	3320	4455	4980	+965	NA	+230
48"	72"	MTM04872	3110	4120	4730	+810	+535	+305
48"	84"	MTM04884	3345	4465	5180	+925	+570	+345
48"	96"	MTM04896	3440	4690	5490	+1035	NA	+380
<i>*Surface material options may be limited above 48" table depth</i>								
54"	84"	MTM05484	3460	4680	5480	+925	+570	+425
54"	96"	MTM05496	3565	4930	5955	+1035	NA	+475
60"	96"	MTM06096	3710	5170	6165	+1210	NA	+570

MOMENT Common Tables

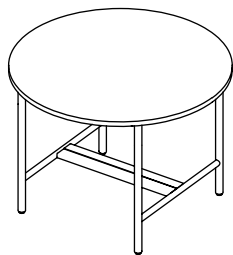
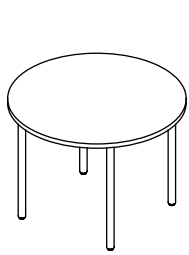

footbar type A

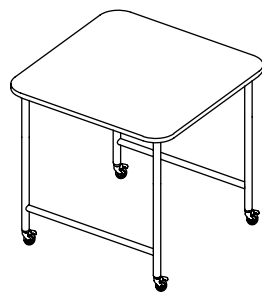
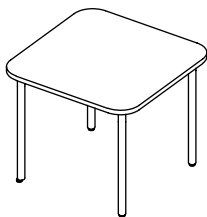

footbar type B

Options / Notes:

Casters: +\$115 (height not altered)

Custom Power Cutouts: +\$185 Table

Height: 29.5" / 36" / 42"+\$415

***Footbar Type B:** 42" tall table ONLY

TFL Edge: edgeband ONLY

HPL Edge: edgeband / MDF 90 /MDF

Knife / MDF trim

PLY Edge: PLY 90 / PLY knife

Bag hooks standard on all tables

Round

Round			Surface Material			Footbars		Cable Cover
D	W	MODEL NUMBER	TFL	HPL/ Mirlux	PLY	TYPE A	TYPE B*	PLY
42"	42"	MTSR4242	2425	3125	3495	+520	+300	NA
48"	48"	MTSR4848	2500	3270	3685	+590	+310	NA
54"	54"	MTSR5454	2835	3600	4245	+635	+500	NA
60"	60"	MTSR6060	3045	3950	4710	+875	+510	NA

Square

D	W	MODEL NUMBER	TFL	HPL/ Mirlux	PLY	TYPE A	TYPE B*	Ply
42"	42"	MTSS4242	2425	3125	3495	+520	+300	NA
48"	48"	MTSS4848	2500	3270	3685	+590	+310	NA
54"	54"	MTSS5454	2835	3600	4245	+635	+500	NA
60"	60"	MTSS6060	3045	3950	4710	+875	+510	NA

MOMENT Table Accessories

	D	W	H	MODEL NUMBER	Price
--	---	---	---	--------------	-------

Pivot Tables

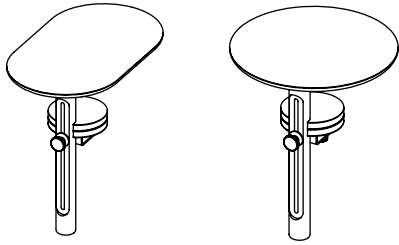

Racetrack

12" 20" 20"

MTAPTO

750

Round

16" 16" 20"

MTAPTR

750

Planters

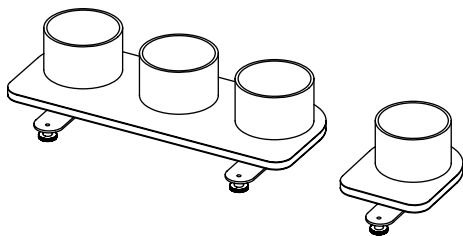

Single

12" 9" 9"

MTAPL1

310

Tripple

12" 24" 9"

MTAPL3

500

TV Mount

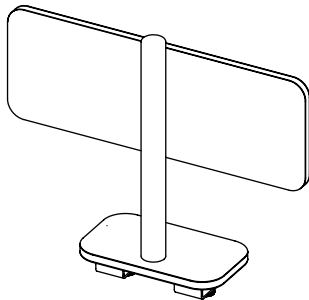

8" 28" 24"

MTATV

875

Pivot Table / Planters / TV Mount can clamp onto any surface less than 1.25" thick

Cable Tower

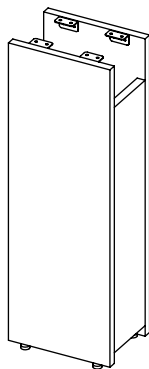

Plywood

7" 10" 28"

MTACT28

625

7" 10" 34.5"

MTACT34

750

7" 10" 40.5"

MTACT40

875

TFL

7" 10" 28"

MTACT28

425

7" 10" 34.5"

MTACT34

475

7" 10" 40.5"

MTACT40

525

All tables come with 5 under surface cable clips and 3 cable straps for table legs

The heights of the Cable Tower correspond to 29.5" / 36" / 42" table heights

The Cable Tower can be mounted anywhere under the table surface

MOMENT Table Cable Management

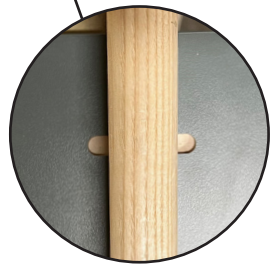
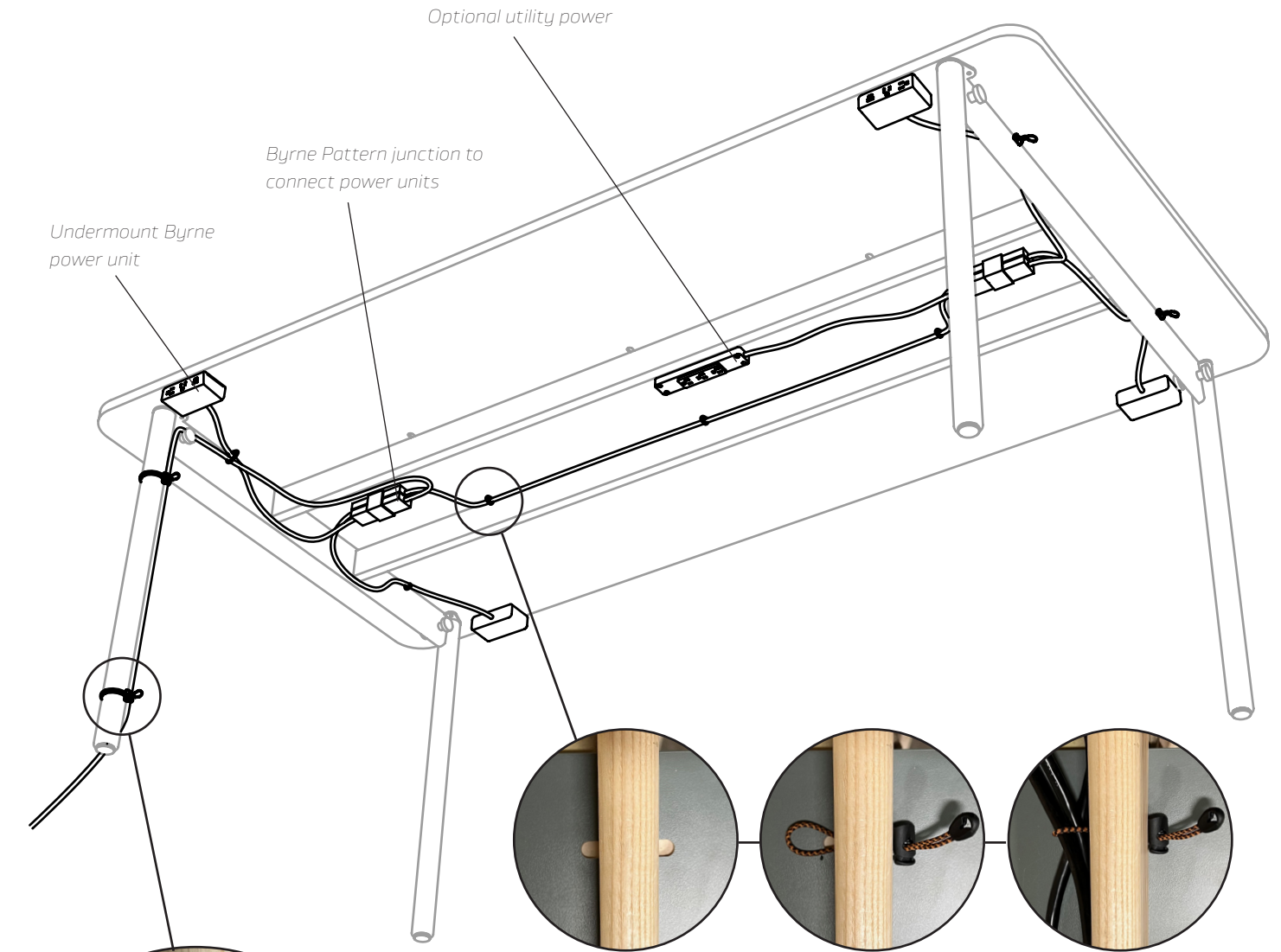

There are slots routed between the surface and the wood frame.



Bungee cords can be fed through these slots.



These bungee cords can be used to manage cables under the surface.



Adjustable bungee cords offer user configurable cable management down any table leg

Standard on all tables:

Under Surface Cable Bungee

6x



Leg Cable Bungee

2x

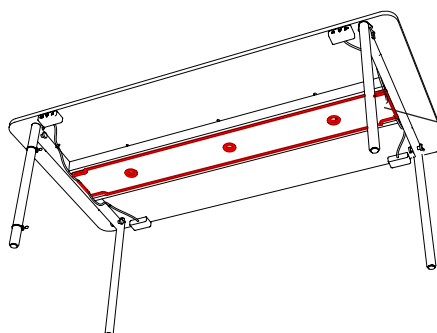

Optional plywood cable cover with magnetic attachment

MOMENT Table Power Placement

Social Tables

Meeting/Perch Tables

Community Tables

Under Surface Perimeter Power

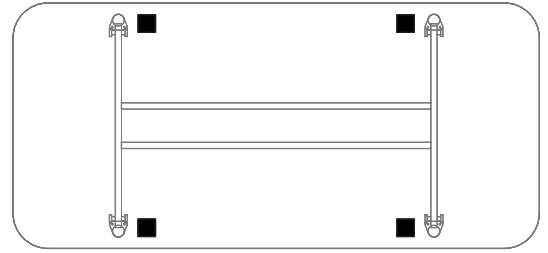
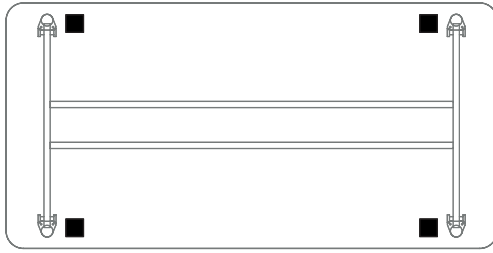
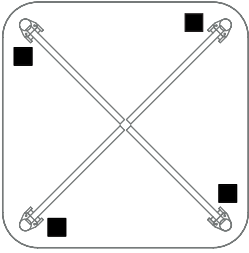

All power units are 2" back from the edge of the surface and 2" in from the interior of the table legs

Single In-Surface Power

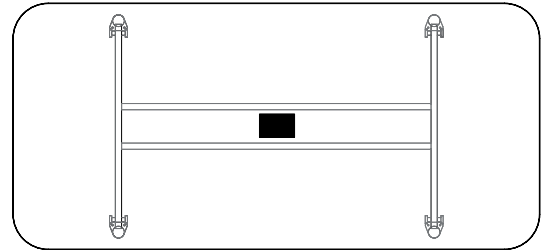
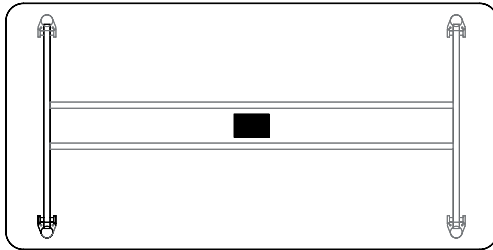
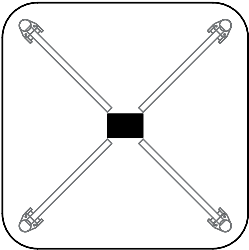

Double In-Surface Power

NA

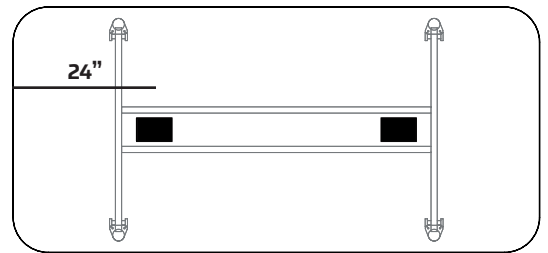
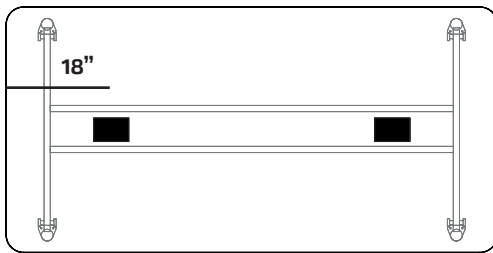

Grommet Locations

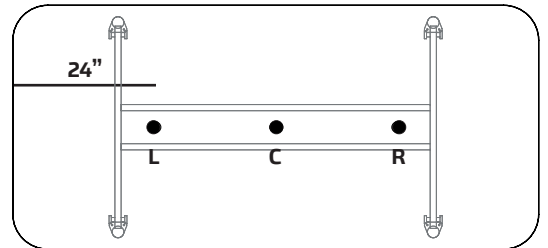
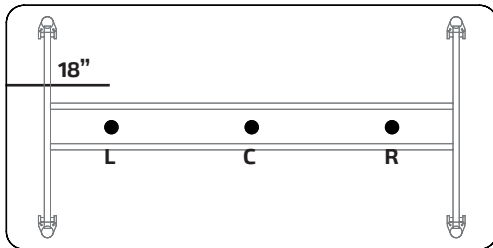
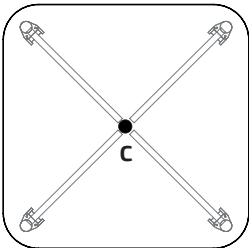

If a grommet is specified in the same location as a power unit it will be pushed 2" interior of the power unit or 2" to the right depending on the configuration. **+\$50 list per grommet**









MOMENT Table Power Offering

Notes:

All multi-unit configurations (perimeter power / inline utility power / or double in-surface power) are accomplished using Byrne Electric's Pattern system or our Built in USB C charging system. This mean all individual power units or ports are chained together and a single cord (infeed) powers the whole system.

Options:

Braided Infeed Cord: +\$125
Hardwired Infeed: +\$250
 Finish option on Byrne website.
 Select finishes may add extra cost.

Power Unit	Description	Perimeter*	Single In-Surface	Double In-Surface**
Built in 100 Watt USB C	4 port: 1 port per leg	2435	NA	NA
	<i>This power solution is proprietary to Makr Furniture and the Moment Tables & Desks. It integrates a 100-Watt USB C charging port into each table leg. This is enough power to charge devices ranging from cell phones to full sized laptops. In addition to power, hardware data, peripherals, and displays can pass through these ports with the use of data Hubs. Makr can work with your technology needs to help specify the proper Hub for your application. A data hub is not included in this price.</i>			
Finch	 3 port: 2 PWR / USB A + C	2765	NA	NA
Dean	 3 port: 3 PWR 3 port: 2 PWR / 1 USB A + C	2655 3430	470 625	1260 1590
Ellora B	 4 port: 2 PWR / Dual USB A / 1 Open 4 port: 3 PWR / USB A + C	NA NA	780 780	2425 2425
Pepper	 1 port: 1 PWR	NA	155	905
HQ2	 4 port: 1 PWR / Dual USB A / 2 Qi	NA	1035	3045
Utility Power***	 <i>inline</i>  <i>stand alone</i> 3 port: 3 PWR	310	310	NA

*Perimeter power comes with 4 power units chained together into one system with a single power infeed

**Double in-surface power comes with 2 power units chained together into one system with a single power infeed

***Utility power is mounted under the surface and will be connected in line with the other power units by default. If you want a stand alone utility power unit with its own power cord it will be a 2 port byrne MiniTap and will cost \$145 list.